



IPC

Spare parts list

Ref: IDAF40354

Model: H.P. CLEANER BENZ-C H2515Pi P IPC

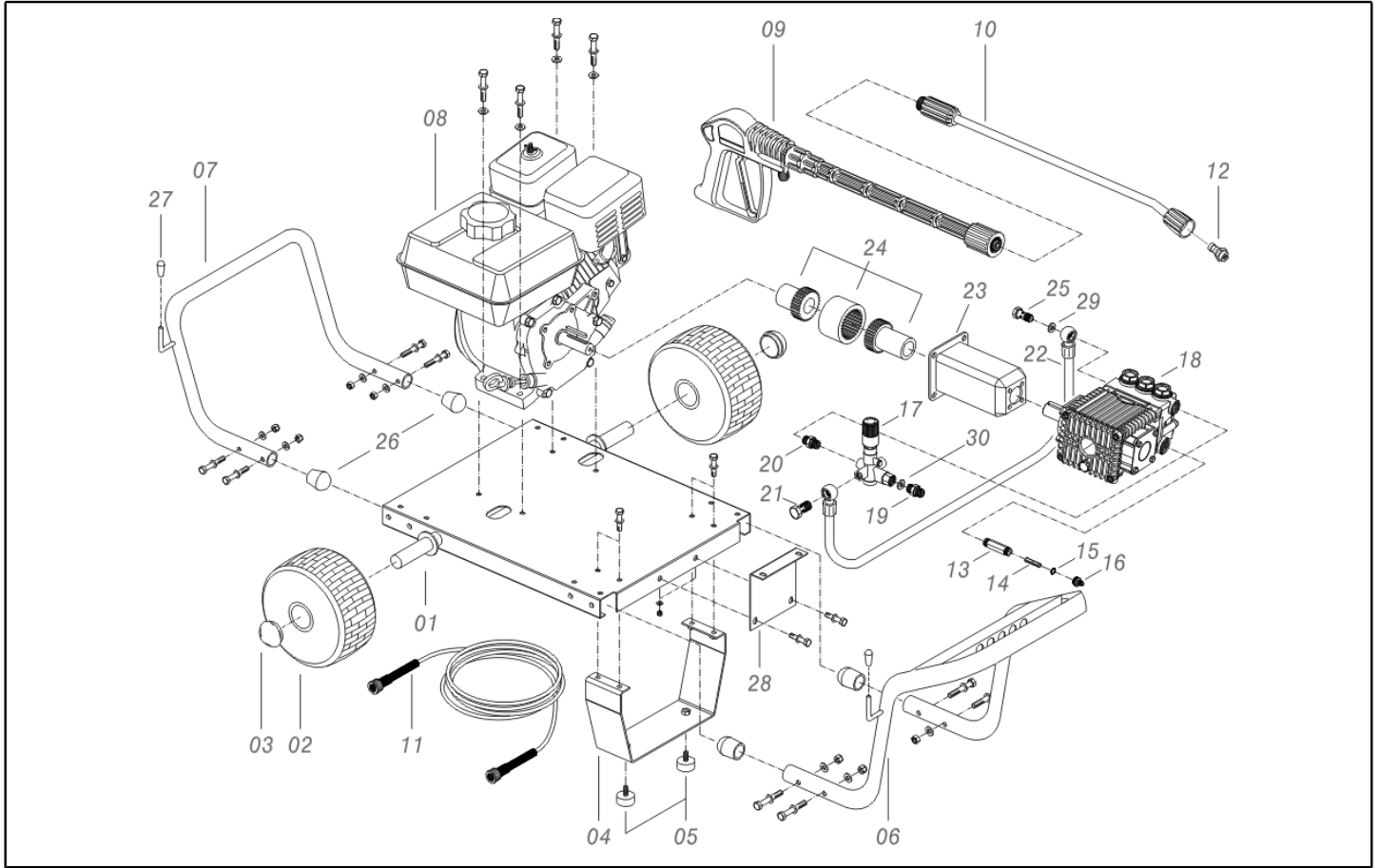

Ref. K	Part n.	Customer part n.	Description	Quantity	Validity		Price
					From	To	
0001	LAFN40179		CHASSIS BENZ HP 9-13	1,00			--
0002	RTRT40006		WHEEL D. 13.5"X 6/6 -D.25 PN.	2,00			--
0003	VTVR01268	00001268	HUB CAP D. 25	2,00			--
0004	LAFN40181		FOOT BENZ HP 9-13	1,00			--
0005	MPVR60726	00060726	VIBRATION DAMP. TCC48X25- 1M8X16 60SH GMM	2,00			--
0006	LAFN40188		HANDLE BENZ HP 9-13	1,00			--
0007	LAFN40183		BUMPER BENZ HP 9-13	1,00			--
0008	MOSC40002		ENGINE MOTOR HONDA GX390 UT2 QX Q4 OH	1,00	01/10/2011		--
0008	MOSC71925	00071925	ENGINE MOTOR HONDA GX390 QX 13HP AV.MA	1,00		30/09/2011	--
0009	IPPR40010		GRIP G 5100+P.330 +M22 SW.M V	1,00	16/04/2014		--
0009	IPPR89429		GRIP G 4500 - P.330 -M22SW.M V	1,00		15/04/2014	--
0010	LCPR40013		EXTENSION P 70 - HYPERJET 1/4F	1,00			--
0011	TBAP25324	00025324	H.P. HOSE R1 MT 10 5/16" C/2 IRV ZC	1,00			--
0012	UGLN49990	00049990	NOZZLE LECH 1/4 25034	1,00			--
0013	RCDS46109	00046109	NIPPLE 3/4 - 1/2 RYL INX	1,00			--
0017	VVAZ40004		VALVE BP 93 C/M.310B. 3/8-1/4F	1,00			--
0018	PPAP40032		PUMP *44" WW965 DX T.OT.	1,00			--
0019	RCIN09348	00009348	MALE COUPLING 3/8MA L=32	1,00			--
0020	RCDS12121	00012121	NIPPLE 3/8 - 3/8 SV/CN	1,00			--
0021	RCDS02612	00002612	SCREW G 1/4 A.P.	1,00			--
0022	TBBP18076	00018076	BY-PASS HOSE L=390 1/2OCC -1/4OCC 90°	1,00			--
0023	MFVR24511	00024511	FLANGE IP HP 8-18	1,00			--
0024	FGGT40002		FLEX. COUPLING HP 13.0 SM Z.28 1"-24 CPL	1,00			--
0025	RCDS10271	00010271	SCREW G 1/2 L=41.5	1,00			--
0026	MPVR01697	00001697	PROD D.30 1.02.109	4,00			--
0027	MPVR32471	00032471	PROD D. 8 BK	2,00			--
0028	LAFN40192		SUPPORT BRACKET BENZ HP 13.0 HS	1,00			--
0029	VTRS12491	00012491	WASHER 1/2	2,00			--
0030	VTRS00548	00000548	WASHER D.17,5X23X1,5 (3/8)RM	1,00			--

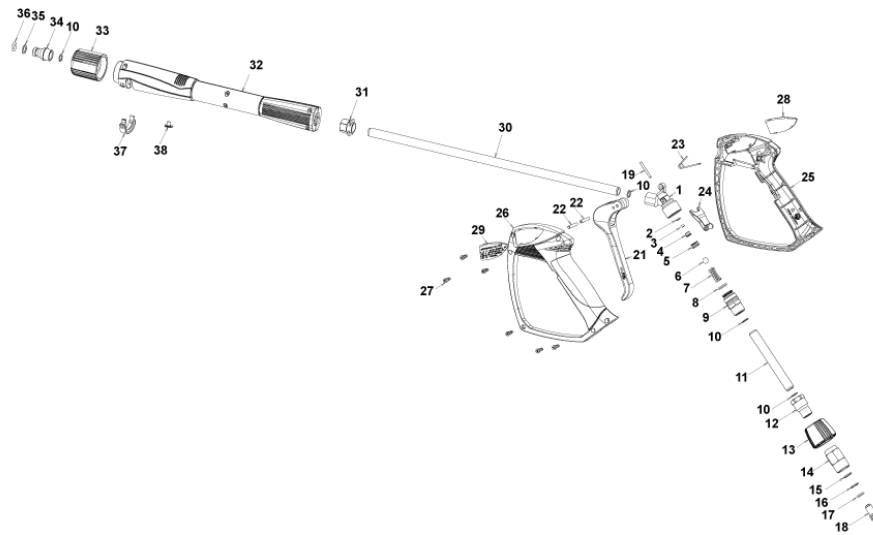

Ref. K	Part n.	Customer part n.	Description	Quantity	Validity		Price
					From	To	
0001	PVVR40381		GUN BODY G 5100 G1/4F	1,00			--
0002	S GUVR40074		ANTI-EXTR.RING D. 3 X 7.4X1.3	1,00			--
0003	S GUGO21835	00021835	O-RING D. 2.84 X 2.62 VIT. 80SH	1,00			--
0004	PVVR40382		PISTON GUIDE G 5100	1,00			--
0005	S PVVR40112		BALL SEAT G 5000	1,00			--
0006	S SFVR27026	00027026	BALL D.11/32" INX	1,00			--
0007	MLML40016		SPRING D. 9.4 x21.5x1.6 G5000	1,00			--
0008	GUGO12322	00012322	O-RING D. 14 X 1.78 NBR 90SH	1,00			--
0009	PVVR40383		CONNECTOR COLL.G5100 1/4F	1,00			--
0010	VTRS40017		WASHER D. 8.2X11,4X1.00	4,00			--
0011	PVVR40384		TUBE G 1/4" L.105	1,00			--
0012	RCIN40022		CONNECTOR SWIV G5100 1/4F	1,00			--
0013	MPVR40486		RING NUT G 5100 SW. GR.	1,00			--
0014	RCIN40021		JOINT SWIV 5100 M22	1,00			--
0015	S GUVR40075		ANTI-EXTR.RING D. 10 X14X1.5	1,00			--
0016	S GUVR40076		ANTI-EXTR.RING D. 11.2X14X1.2	1,00			--
0017	S GUGO15295	00015295	O-RING D. 10.82 X 1.78 VIT 80SH	1,00			--
0018	PVVR40386		SCREW SW. G 5100	1,00			--
0019	PVVR40387		SMALL PISTON G 5100	1,00			--
0021	MPVR40487		TRIGGER G 5100-SW	1,00			--
0022	VTVR40047		PLUG D. 4X29	2,00			--
0023	MLML40029		SPRING G 5100	1,00			--
0024	MPVR40488		SAFETY-DEVICE G 5100-SW	1,00			--
0025	MPVR40489		SHELL G 5100-SW DX	1,00			--
0026	MPVR40490		SHELL G 5100-SW SX	1,00			--
0027	VTVT40043		SCREW AF 4X 14 HILO ZN.N	6,00			--
0028	MPVR40491		PLATE G 5100 GR.DX	1,00			--
0029	MPVR40492		PLATE G 5100 GR.SX	1,00			--
0030	LCPR40086		TUBE 1/4 L=420 ZC. 0°	1,00			--
0031	MPVR40493		CONNECTOR G 5100-SW	1,00			--
0032	MPVR40494		PROTECTION P 420 C/AN.	1,00			--
0033	PVVR40119		CONNECTION M22X1.5 IRV G5000	1,00			--
0034	RCIN40009		GUDGEON G 1/4 F IRV G5000	1,00			--
0035	GUVR40034		ANTI-EXTR.RING D. 10 X14	1,00			--
0036	GUGO01946	00001946	O-RING D. 9.13 X 2.62 VIT 70SH	1,00			--
0037	MPVR40495		CAP G 5100 REM.	1,00			--
0038	MPVR40198		CAP G 5000	1,00			--

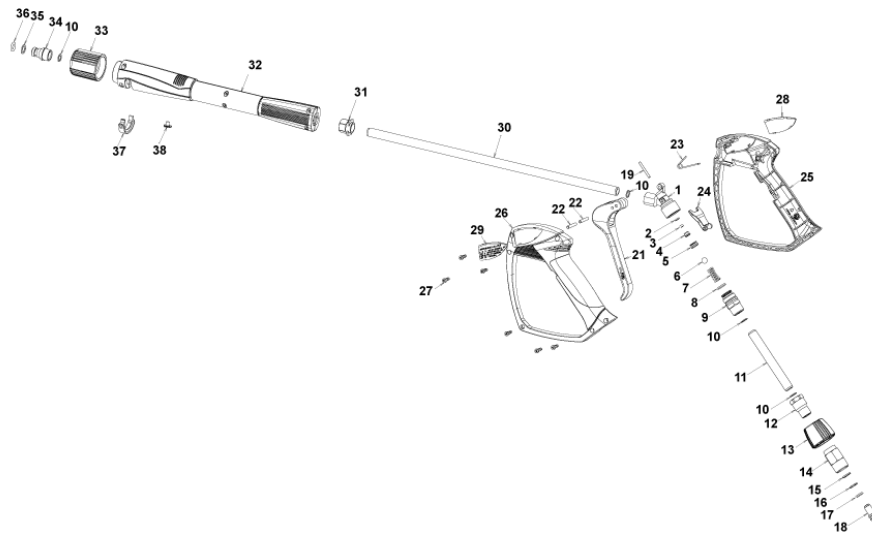

Ref. Part n.	Cust. part n.	Description	Reference	Price
KTRI40242		KIT P 26- 25 G 5100	0002 0003 0005 0006	--
KTRI40243		KIT P 26- 26 SWIVEL G 5100	0015 0016 0017	--

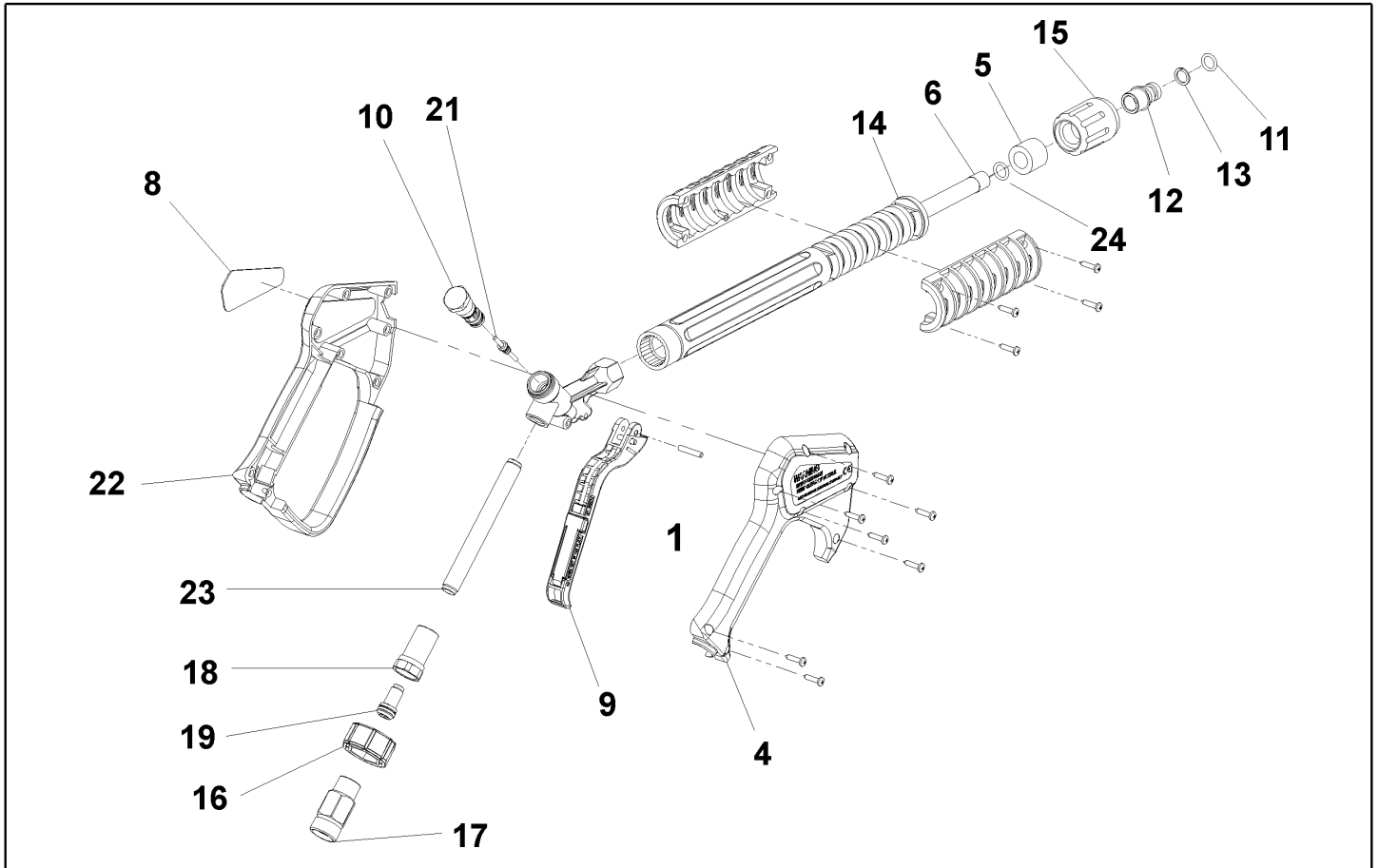

Ref. K	Part n.	Customer part n.	Description	Quantity	Validity		Price
					From	To	
0001	VTVR46568	00046568	PLUG G 4500	1,00			--
0004	MPVR46563	00046563	COVER G 4500	1,00		30/04/2008	--
0004	MPVR40157		COVER G 4500 2V.	1,00	01/05/2008		--
0005	MPVR46572	00046572	SPACER P 330 ST	1,00			--
0006	LCPR46571	00046571	TUBE 1/4 L=352 ZC.	1,00		30/04/2008	--
0006	LCPR40007		TUBE 1/4 L=352 ZC. 2V.	1,00	01/05/2008		--
0008	MPVR46569	00046569	PLATE G 4500 RD.	1,00			--
0009	MPVR40057		TRIGGER G 4500 -SW	1,00			--
0010	PVVR40030		SMALL PISTON TM ST-2300	1,00			--
0011	GUGO10384	00010384	O-RING D. 10 X 2.2 VIT 80SH	1,00			--
0012	RCVR13030	00013030	GUDGEON G 1/4 F L=31.5	1,00			--
0013	GUVR10526	00010526	ANTI-EXTR.RING D.13.9X10.2 C.BZ	1,00			--
0014	MPVR46570	00046570	PROTECTION P 330 ST	1,00			--
0015	PVVR13445	00013445	CONNECTION M 22X1,5 L=45	1,00			--
0016	MPVR40058		RING NUT G4500 SW.	1,00			--
0017	RCIN40001		JOINT SWIV 4500 3/8"F	1,00		30/04/2008	--
0017	RCIN40005		JOINT SWIV 4500 3/8"F 2V.	1,00	01/05/2008		--
0018	RCIN31641	00031641	CONNECTOR SWIV 1500 F	1,00			--
0019	KTRI31645	00031645	KIT P 26- 14	1,00			--
0021	PVVR40031		ROD ST-2300	1,00			--
0022	MPVR46562	00046562	SHELL G 4500	1,00		30/04/2008	--
0022	MPVR40156		SHELL G 4500 2V.	1,00	01/05/2008		--
0023	PVVR40023		TUBE G 1/4" M/M P/SW.	1,00			--
0024	GUGO27021	00027021	O-RING D. 11 X 2.5 EPD 70SH	1,00	01/05/2008		--

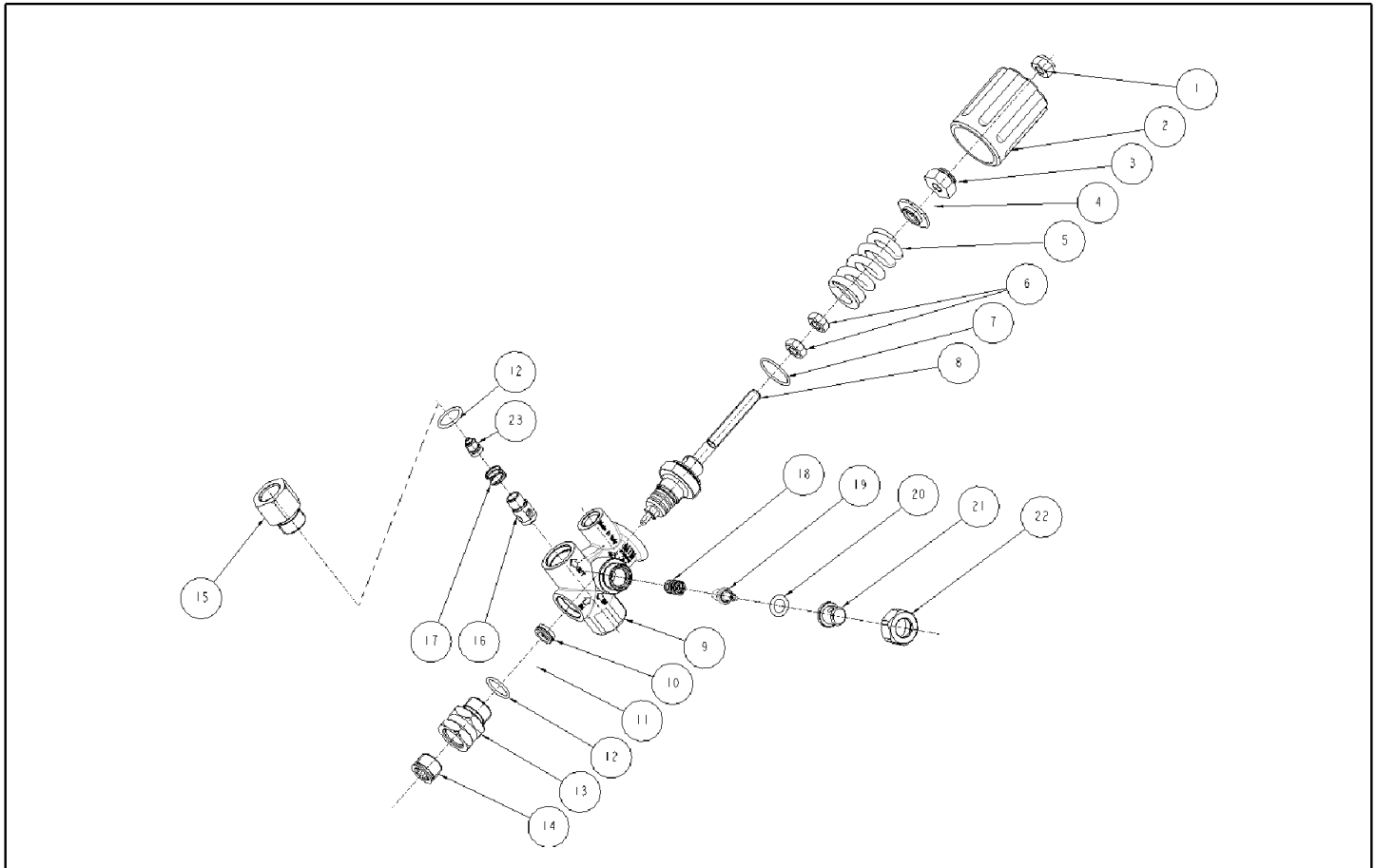

Ref. K	Part n.	Customer part n.	Description	Quantity	Validity		Price
					From	To	
0001	VTDD89669		NUT M 8 X1 AUT. INX A2	1,00			--
0002	MPVR40002		KNOB BP9 BK.	1,00			--
0003	VTDD88134	00088134	NUT M 8 BY-PASS BP91	1,00			--
0004	PVVR88140	00088140	SPRING PLATE BP91	1,00			--
0005	MLML40014		SPRING D.15.6 X27 L=51.5 310B.	1,00			--
0006	VTDD40000		NUT M 8 X1 UNI5588 INX A2	2,00			--
0007	GUGO11652	00011652	O-RING D. 12.42 X 1.78 NBR 70SH	1,00			--
0008	PVVR40016		PUSH ROD BP9 CP.	1,00			--
0009	PVVR40107		VALVE BODY BP 93 3/8"	1,00			--
0010	PVVR88135	00088135	INSERT BY-PASS BP91	1,00			--
0011	SFVR88141	00088141	BALL D.17/32" AISI 440	1,00			--
0012	GUGO03505	00003505	O-RING D. 15.6 X 1.78 NBR 70SH	2,00			--
0013	PVVR88138	00088138	CONNECTOR EASY-ST. BP91	1,00			--
0014	PVVR88139	00088139	CAP 3/8 M BP91	1,00			--
0015	PVVR49638	00049638	CONNECTOR BP91 3/8F	1,00			--
0016	PVVR49636	00049636	SMALL PISTON BP91 C/OR	1,00			--
0017	MLML49637	00049637	SPRING BP91	1,00			--
0018	MLML40015		SPRING D. 9,2X18,26X1 BP 93	1,00			--
0019	PVVR40108		ELEMENT TH. BP 93	1,00			--
0020	GUGO28927	00028927	O-RING D. 9.13 X 2.62 NBR 70SH	1,00			--
0021	PVVR40109		CONNECTOR BP 93	1,00			--
0022	PVVR40110		RING NUT M18X1 BP 93	1,00			--

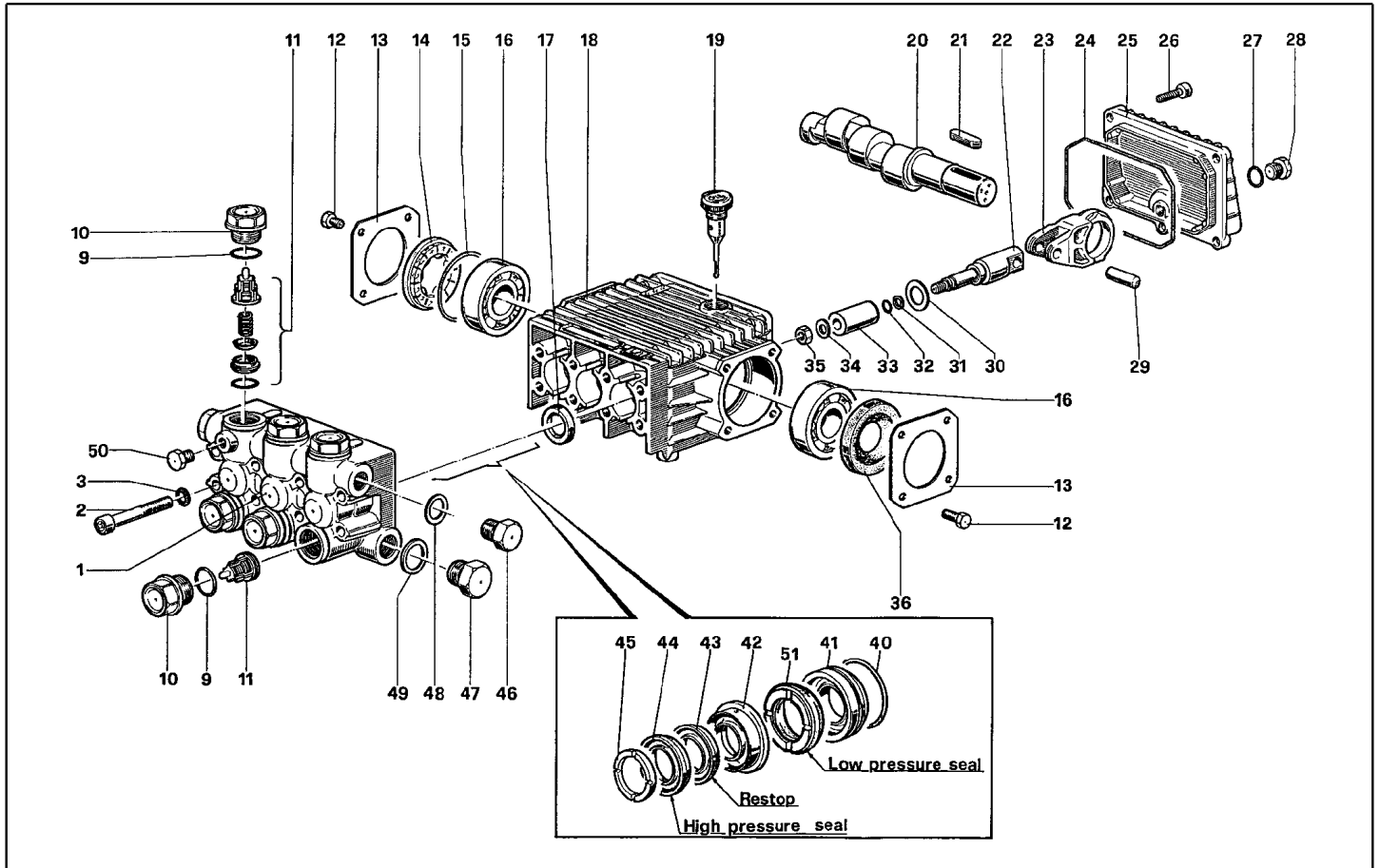

Ref. K	Part n.	Customer part n.	Description	Quantity	Validity		Price
					From	To	
0001	MFVR40009		HEAD "44" WW D.13 OT.	1,00			--
0002	VTVT01121	00001121	SCREW TCEI 8X60 UNI5931	8,00			--
0003	VTRS14242	00014242	WASHER D. 8.4X13X0.8 UNI7064 SCH	8,00			--
0009	S GUGO01033	00001033	O-RING D. 20.24 X 2.62 NBR 90SH	6,00			--
0010	S RCDS28466	00028466	CAP M24X1.5X17 "44"	6,00			--
0011	S VVAM28467	00028467	VALVE UNIT "44" WW136-186	6,00			--
0012	VTVT01109	00001109	SCREW TE M 6X 10 ZC. UNI 5739	4,00			--
0013	MFVR03562	00003562	CRANKASE COVER W 70	1,00			--
0014	MFVR28454	00028454	SPACER "44"	1,00			--
0015	GUGO01040	00001040	O-RING D. 55.56 X 3.53 NBR 70SH	1,00			--
0016	CUVR09654	00009654	BALL BEARING 6305	1,00			--
0017	S GUGO01001	00001001	OIL SEAL 20X 30X 5 NBR70	3,00			--
0018	MFVR28453	00028453	PUMP CRANKCASE "44"	1,00			--
0019	PVVR01089	00001089	OIL DIPSTICK W 70	1,00			--
0020	ALMO28464	00028464	SHAFT "44" WW 136	1,00			--
0021	VTVR09510	00009510	KEY 8X7X35	1,00			--
0022	PVVR40058		PISTON GUIDE "44" D.13	3,00			--
0023	BLVR28459	00028459	CONNECTING ROD "44"	3,00			--
0024	GUGO18695	00018695	O-RING D. 101.27 X 2.62 NBR 70SH	1,00			--
0025	MFVR28460	00028460	CRANKASE COVER "44"	1,00			--
0026	VTVT01114	00001114	SCREW TCEI 6X14 UNI 5931	5,00			--
0027	GUGO01036	00001036	O-RING D. 10.82 X 1.78 NBR 70SH	1,00			--
0028	RCDS01088	00001088	CAP 1/4X 9 M WW90	1,00			--
0029	PVVR28458	00028458	GUDGEON D.10X29.5 "44"	3,00			--
0030	VTRS40006		WASHER D. 7,1X28 X0,5	3,00			--
0031	GUVR10257	00010257	ANTI-EXTR.RING WW161	3,00			--
0032	GUGO01055	00001055	O-RING D. 5.28 X 1.78 VIT 70SH	3,00			--
0033	PIVR40001		PISTON D.13X45 "44"	3,00			--
0036	GUGO28465	00028465	OIL SEAL 25X 62X10 NBR70	1,00			--
0040	S GUGO01039	00001039	O-RING D. 31.47 X 1.78 NBR 70SH	3,00			--
0041	S PVVR40059		PACKING RETAIN. D. 13 "44"	3,00			--
0042	S PVVR40060		INTERMED. RING D. 13 "44"	3,00			--
0043	S GUVR40023		ANTI-EXTR.RING D. 13 X17X2	3,00			--
0044	S GUVR40024		PACKING D. 13 H.P.	3,00			--
0045	S PVVR40061		HEAD RING D. 13 "44"	3,00			--
0046	RCDS01090	00001090	CAP 3/8X13 M WW90	1,00			--
0047	RCDS01091	00001091	CAP 1/2X10 M	1,00			--
0048	VTRS01074	00001074	WASHER D.17,05X22,3 X1,5	1,00			--
0049	VTRS00549	00000549	WASHER D.21,5X27X1.5 (1/2) RM	1,00			--
0050	RCDS09704	00009704	CAP G 1/8 KR	1,00			--
0051	S GUVR40025		PACKING D. 13 L.P.	3,00			--

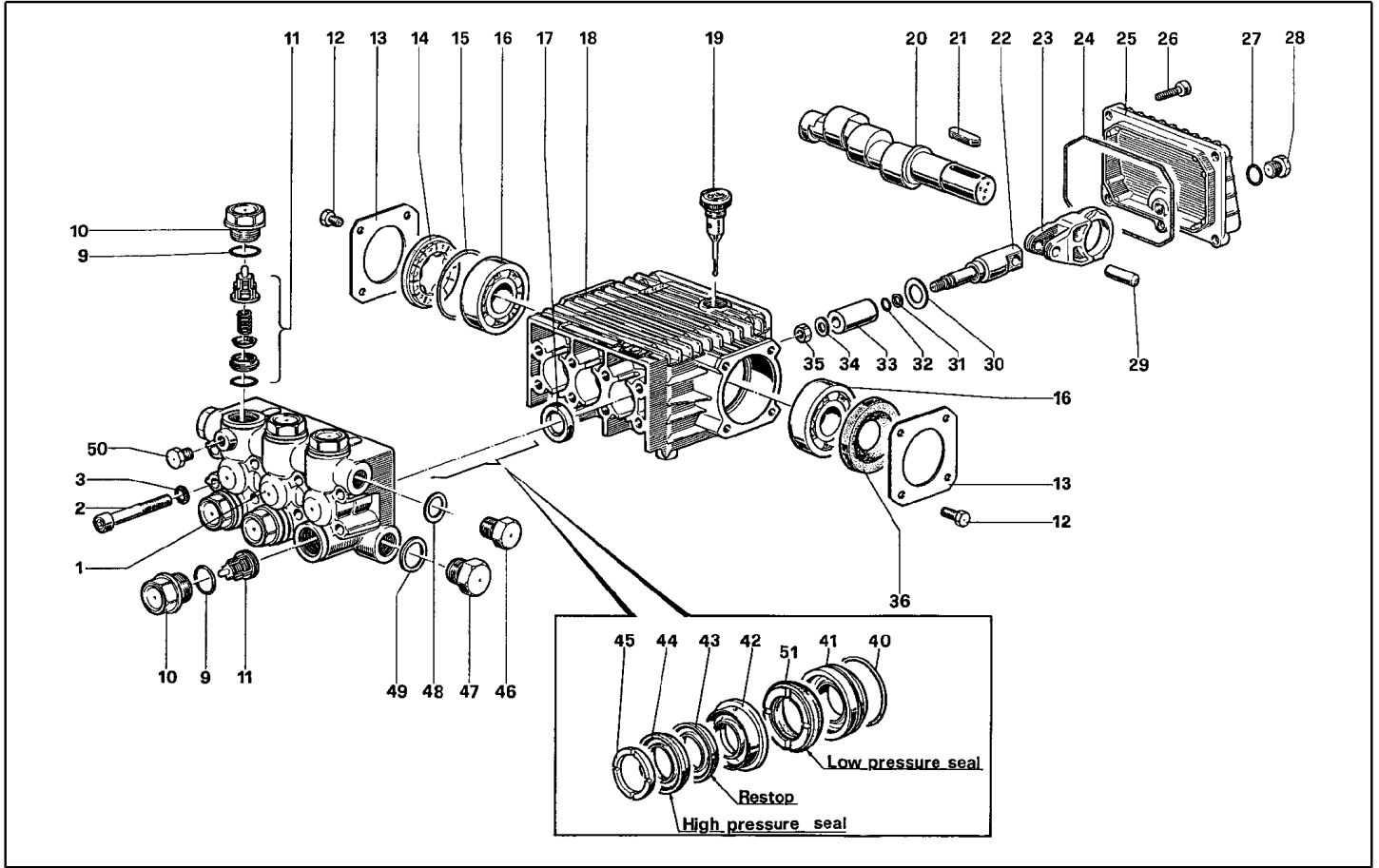

Ref. Part n.	Cust. part n.	Description	Reference	Price
KTRI18585		KIT P 23	0017	--
KTRI28508		KIT P 15-123	0011	--
KTRI28510		KIT P 15-124	0009 0010	--
KTRI40042		KIT P 15-152	0040 0041	--
KTRI40043		KIT P 15-153	0043 0044 0051	--
KTRI40044		KIT P 15-154	0042	--
KTRI40045		KIT P 15-156	0040 0041 0042 0043 0044 0045 0051	--